

**schaerer**  
swiss coffee competence

## Coffee Prime

The first choice for connoisseurs  
and money-conscious consumers



# Barista inside

## **Pure temptation**

Our love for coffee, our many years of coffee expertise and the craftsmanship of a barista are in every Schaerer coffee machine. Espresso, cappuccino or latte macchiato – on the inside of our coffee machines, all the details are perfectly coordinated to prepare beverages that are equal in taste and appearance to the coffee creations hand-crafted by baristas. Barista inside – for delicious coffee and milk foam no one can resist. ☘



# FIRST-CLASS DELICIOUS COFFEE FOR THE HIGHEST STANDARDS

You're looking for a coffee machine which offers the highest beverage quality with maximum flexibility and easy cleaning? Which grows along with your requirements without add-ons? And all that at an economic price? Then the Schaerer Coffee Prime is the right choice for you.

## Your requirements are decisive

The Schaerer Coffee Prime is ideal for self-service in offices, hospitals, petrol stations or universities. Countless configuration options makes it possible to adapt the Coffee Prime exactly to the requirements: Fresh milk or powder systems, cooling units, a second grinder, cup dispenser, payment systems, Powerpack for more output or the integration of our M2M Coffee Link telemetry solution – you alone decide which equipment your Coffee Prime should have. Decisive for vending operations: The modular concept of grinders and powder systems enable very easy retrofitting and conversion. The combination with a stylish trolley – including water tank and refrigerator – even makes it possible for you to use the system as a mobile unit at events or conferences. ☑

## Cost- and time-saving operation

Several factors contribute to the particularly economic and time-saving operation of the Coffee Prime. An advantage is the reduced staff costs: With the Coffee Prime, all work steps are visualised in the 7" TouchIT display with colour-guided operation, making operation child's play. The minimised power consumption thanks to the compact machine components, fully-insulated boiler and the automatic standby mode when not in use all have a positive effect on the operating costs. Last but not least, the modular design of the Coffee Prime increases your security of investment: You can get started with a low level of investment with the basic equipment and retrofit the system at any time in line with the development of your coffee service needs. ☑

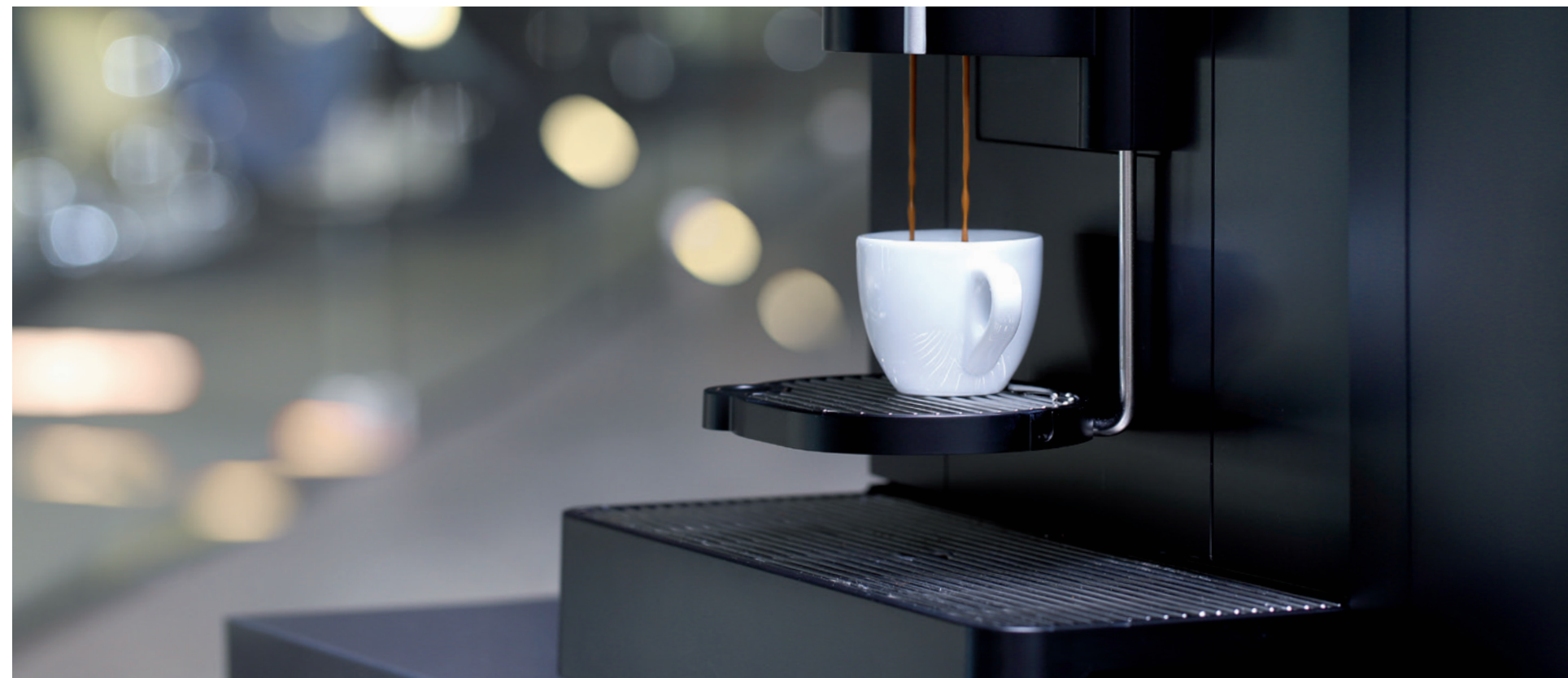

Why should you choose the Coffee Prime?

**For anyone who would like to have the Coffee Prime for mobile use, such as event catering**

- The coffee machine only needs a power connection
- No mains water supply necessary
- Can be combined with a stylish trolley and individually equipped with an external drinking water tank, a closed tank for residual water, refrigerator, etc.

**For the vending machine sector**

- Easy supply/easy filling
- Easy cleaning: Automatic cleaning program for the coffee system; Replacement of NcFoamer (HACCP-compliant milk system concept) every 2 to 7 days, depending on the operational concept

**For anyone who offers self-service solutions**

- Optimal self-service capability thanks to TouchIT
- Display use for promotional messages/special offers
- Connection to common market payment systems





# VARIETY OF BEVERAGES AND FLEXIBILITY FOR YOUR COFFEE SERVICE BUSINESS

With the Schaerer Coffee Prime, you remain flexible. Offer up to 40 different drinks, get an extra power boost or expand your offer if needed with our beverage concept for freshly-brewed coffee – the Coffee Prime Brew.



## Gourmet beverage at the push of a button

The Schaerer Coffee Prime produces up to 40 freely-programmable beverages with a consistently high level of quality at the push of a button. In no time, you can prepare delicious creations from freshly-ground coffee beans, fresh milk, or milk or chocolate powder. In addition, the Coffee Prime provides hot water for the preparation of tea or instant soup. Separated preparation systems and outlets prevent contamination from other beverages. If necessary, combination operation with fresh milk and milk powder is possible – even lactose-free beverages can be offered. Professional fine-tuning of all beverage parameters guarantees a consistent flavour experience for all beverages. ☒

## Beverage variety at peak times

You would like to offer your customers freshly-ground brewed coffee even at peak times during breakfast service, for example? Then the sister coffee machine Coffee Prime Brew is the ideal addition to your operations. With the Coffee Prime Brew, you can brew the highest-quality filter coffee from freshly-ground beans at the push of a button. Your guests enjoy fresh, delicious brewed coffee at any time – no matter whether you are offering large or small amounts such as small pots or cups. Thanks to the design based on the Coffee Prime, the Coffee Prime Brew is also the perfect optical addition to your speciality coffee machine. ☒





# 7" Touch / Touch Screen User Panel

Visualisation of all work steps;  
use as a marketing tool  
for advertisement purposes

# Barista button

For setting the  
flavour intensity

# Disposable NcFoamer concept

Exchange of all milk-supplying  
components every 2 to 7 days  
instead of daily cleaning

## TOP EQUIPMENT, TOP PERFORMANCE

Performance, operating convenience, individual configuration – the Coffee Prime scores points in all areas.

# Separate preparation system

Multiple outlets  
for pure beverages

### Schaerer M2M Coffee Link

The M2M Coffee Link is available for the Coffee Prime and has everything you expect from a powerful telemetry system. At the push of a button, all important information is clearly displayed and can be processed immediately using the report and export functions. From the current extraction time of an espresso and real-time reports to coffee machine utilisation across all sites. The automatic data transfer between coffee machine and administration actively supports you in quality assurance as well as monitoring and optimisation of your individual processes. ☑

### Easy cleaning and maintenance

The automatic cleaning program is supported by animations and meets the strictest hygiene standards. A special feature is the HACCP-compliant disposable NcFoamer concept developed by Schaerer: Instead of time-intensive, daily cleaning of the milk system, the recyclable NcFoamer only has to be exchanged every 2 to 7 days, depending on the operational concept. For efficient maintenance of the Coffee Prime, the service technicians have access to all important components after removing only one screw. ☑

### Powerpack for improved performance

The Powerpack increases performance wherever large milk beverages are offered: Cappuccinos, latte macchiatos and the like in XXL "to-go" version can be whipped up much faster with the same delicious taste with the Powerpack at 3 kW (or 2 kW) of power per boiler. And with maximum container sizes, you will profit from significantly more autonomy in structuring the daily tasks involved in the supply of coffee. ☑



### Other features of the Schaerer Coffee Prime

- ☑ Grounds container for about 40 coffee ground cakes
- ☑ Overall and single beverage counter
- ☑ Display messages for "Fill water tank", "Fill bean hopper" and "Empty grounds container"
- ☑ Colour-guided operation for cleaning and exchanging disposable parts
- ☑ Modular design: Countless expansion options for more flexibility

# MORE SUCCESS WITH MORE EQUIPMENT

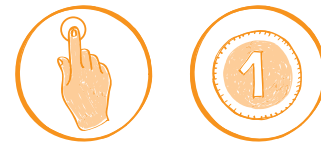

## Operation and cleaning



**Double outlet for coffee.**  
Higher coffee beverage output by pouring double drinks.

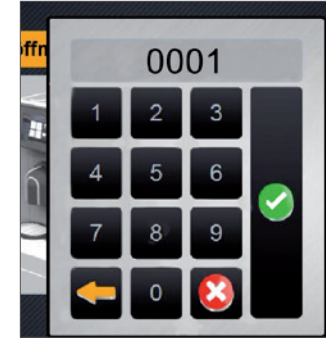

**Code-protected access** to bean hopper, powder system, grounds container and water tank.



Display with **customised button layout** and **promotional messages** between and during beverage preparation.



**Rotatable cup platform** (height 100 mm, optionally 85 mm) and drip tray. Drip grid made of chromium nickel steel, dishwasher proof.

## Payment systems

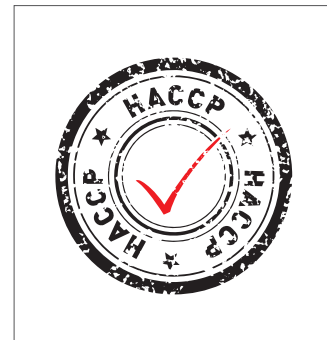

All milk systems from Schaerer are in line with the **HACCP hygiene analysis** and feature an **automatic cleaning program**. All coffee-supplying elements are automatically cleaned – quickly, easily and reliably. Periodic intermediate flushings can be programmed.



No cleaning necessary for the milk system: **Ecological disposable concept with NcFoamer** (Non cleaning Foamer). The milk system is like new after every replacement. Adjustable flushing of the milk system guarantees hygienic operation in line with the operational concept.



**Integrated coin tester**, can be separately locked (installation also possible at a later time).



Standard payment systems as per MDB standard. The **coin changer, card reader**, etc. can be easily connected to the coffee machine.

## Beverage diversity

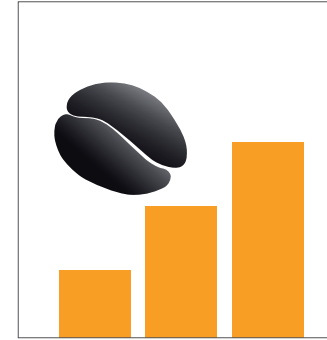

**Barista button** for flexible setting of flavour intensity.

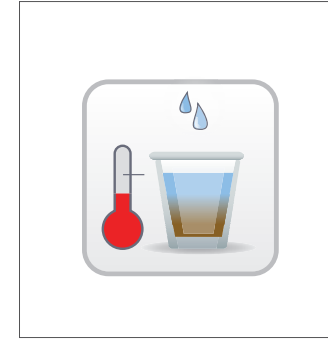

**Hot water** can be set between 40 – 85°C for instant products.

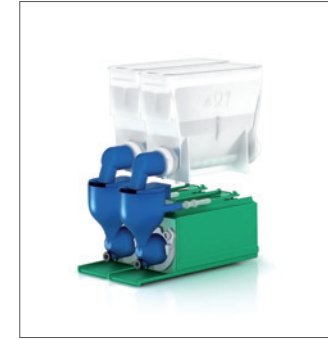

**Up to 2 powder systems** for one or two powder types (700 g/950 ml each). Wider variety of beverages thanks to the use of milk powder, chocolate powder, instant powder and separate preparation systems, for example.



**Up to 2 grinders with bean hopper** for 600 g of roasted coffee beans each, with LED lighting. Blending of beans from both grinders possible.



**Dual milk system with fresh and powder milk** – even lactose-free drinks can be offered.

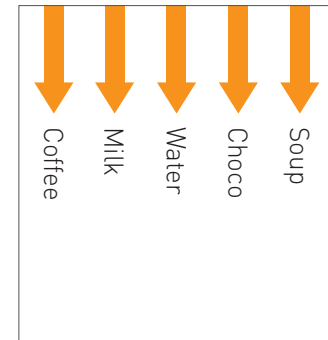

**Multiple outlets** guarantee pure beverages by preventing contamination.



## Expansion options

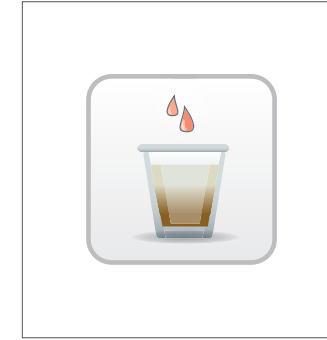

**Brewing accelerator** for higher output where large milk based drinks are served.



**Large bean hopper** for 1200 g of beans (with LED lighting) with 1 grinder.

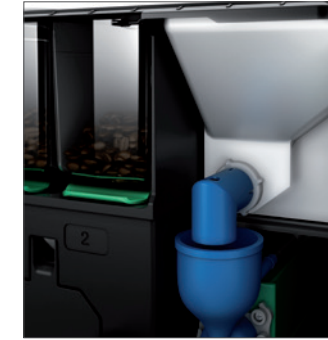

**Large powder container** (1400 g/2000 ml).



**Side cooling unit with compressor** for storage and cooling of two-gallon containers or a 10-litre container of milk (hygiene standard in line with HACCP concept).



**Under-machine cooling unit** for space-saving milk storage (9.5 l capacity).

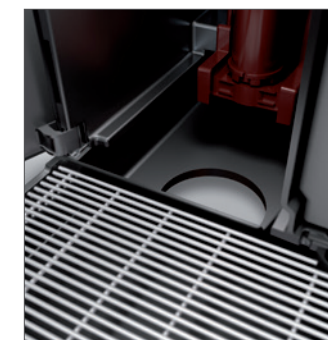

**Under-counter grounds disposal** (possible without converting the machine).

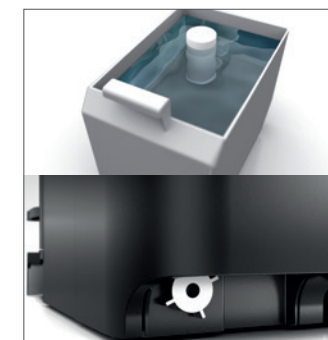

**Aquachange**, conversion of drinking water tank (5.2 l) to mains water supply possible by in-house technician.



**Dispenser for three different cup sizes** (diameter in mm: 60-74/75-82/83-90); three containers for extras, e.g. stirrers, sugar, cream, etc.

# CONFIGURATIONS



**Complete equipment**  
Schaerer Coffee Prime with fresh milk system, side cooling unit, cup dispenser and under-counter units.



**Space-saving**  
Schaerer Coffee Prime with fresh milk system and under-machine cooling unit, perfectly suited for self-service operation.

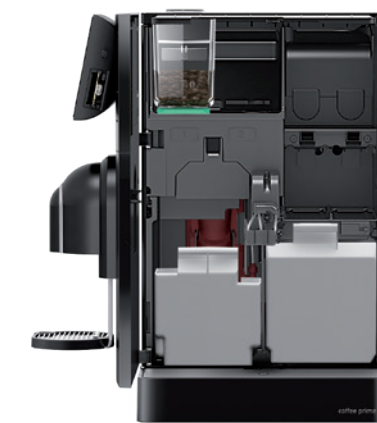

Standard

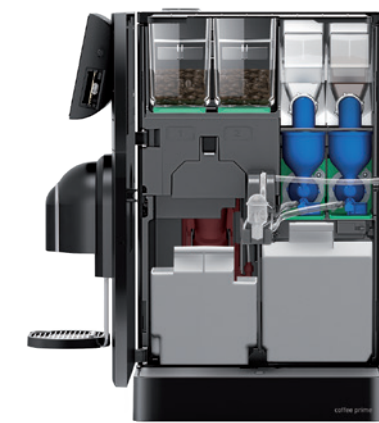

- 2 grinders
- 2 powder systems
- Disposable concept for fresh milk system with NcFoamer

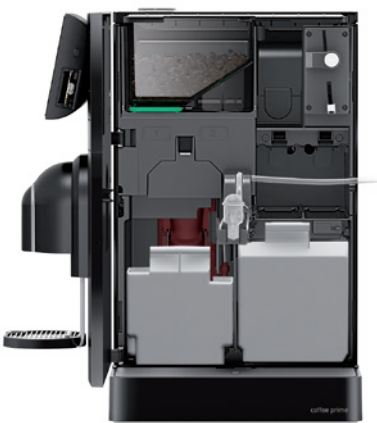

- 1 grinder
- Integrated coin tester
- Disposable concept for fresh milk system with NcFoamer



# CONFIGURATIONS AND TECHNICAL DATA

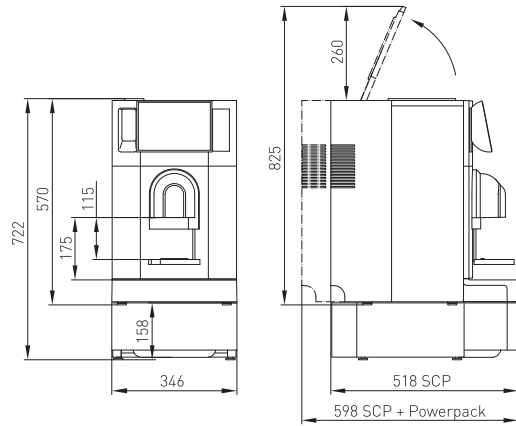

Schaerer Coffee Prime with Powerpack and under-machine unit

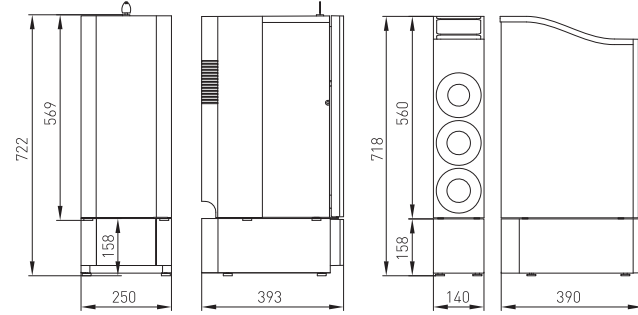

Side cooling unit with base

Cup dispenser with base

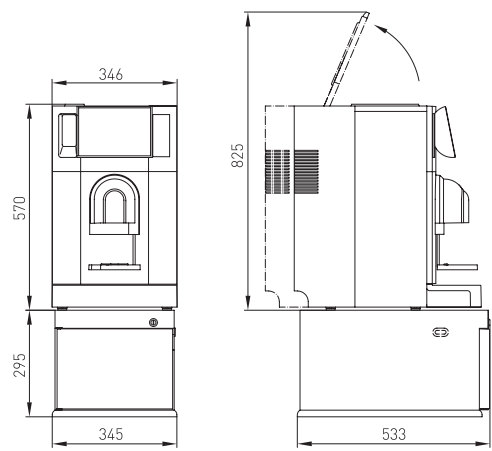

Under-machine cooling unit under coffee machine

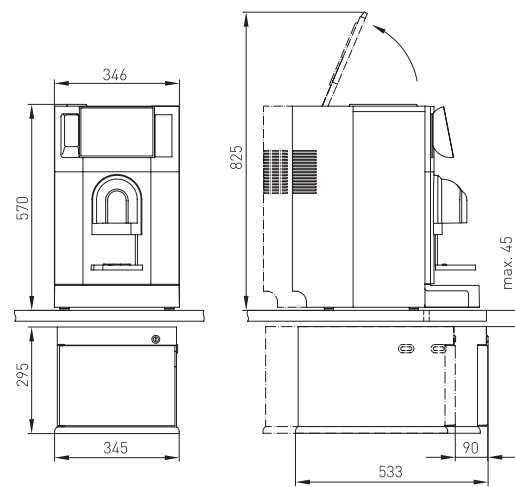

Under-machine cooling unit under counter

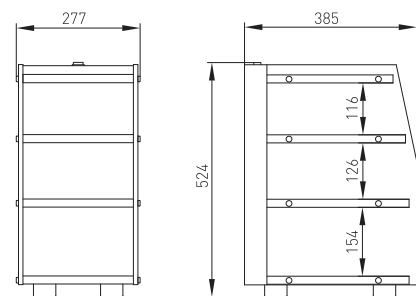

Cup warmer

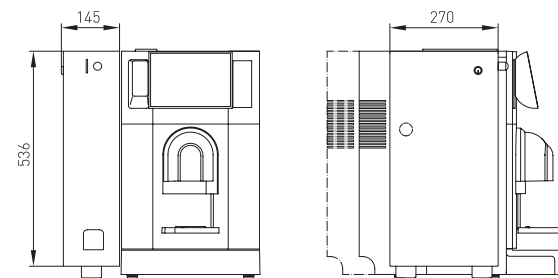

Coin changers

Category	Equipment and options	Schaerer Coffee Prime	Schaerer Coffee Prime with Powerpack
		1.35 kW	3 kW (2 kW (CHI))
Output per day	Suggested beverage output	100	150
Output per hour	Espresso (according to HKI standard)	120	120
	Coffee (according to HKI standard)	85	95
	Cappuccino (200 ml/8 oz)	90	110
	Cappuccino (320 ml/12 oz)	60	90
	Cappuccino (470 ml/16 oz)	35	50
Range of drinks	Ristretto	x	x
	Espresso (according to HKI standard)	x	x
	Coffee (according to HKI standard)	x	x
	Milk coffee/bowl	x	x
	Cappuccino (according to HKI standard)	x	x
	Latte Macchiato	x	x
	Chociatto	x	x
	Hot milk foam	x	x
	Hot water	x	x
	Instant beverages (e.g. tea, soup etc.)	x	x
Version	Self-service mode	s	s
	Number of possible beverages (programmable)	40	40
	Cup platform	s	s
	Single outlet	s	o
	Double outlet	o	s
Grinders	1 grinder	s	s
	2 grinders	o	o
	Bean hopper [g]	600	600
	Large bean hopper [g]	1200	1200
Boiler	Hot water boiler for coffee	s	s
	Steam boiler	o	o
Milk system and cooling units	Milk Smart (MS)	o	o
	Side cooling unit (SCU)	o	o
	Under-machine cooling unit (UMCU)	o	o
Powder system	Powder container [g]/[ml]	1400 g/2000 ml	1400 g/2000 ml
	Twin powder container [g]/[ml]	2 x 700 g/2 x 950 ml	2 x 700 g/2 x 950 ml
	Topping (1 x topping powder), e.g. milk powder	o	o
	Chocolate (1 x chocolate powder)	o	o
	Chocolate/Topping (1 x chocolate and 1 x topping powder)	o	o
	Twin topping (2 x topping powder)	o	o
	Chocolate topping (2 x chocolate powder)	o	o
	Instant powder	o	o
General options	Brewing accelerator	o	o
	Grounds container [coffee grounds cake]	40	40
	Under-counter grounds disposal	o	o
	Base + grounds container [coffee grounds cake]	o [100]	o [100]
	Lighting	s	s
Payment system	Payment systems (MDB-S/DIVA2/DIVA2 Max)	o	o
	Coin and token tester	o	o
	Coin changers	o	o
	M2M Coffee Link	o	o
Colour	Titanium silver	s	s
	Black	s	s
	Special colour	o	o
Dimensions and weight	Width [mm]	346	346
	Depth [mm]	518	598
	Height [mm]	570	570
	Weight [kg] (net)	25	33
Power supply and consumption	1L, N, PE: 220-240 V ~ 50/60 Hz	2000-2400 kW/10-16 A/3 x 1 mm <sup>2</sup>	2800-3300 kW/16 A/3 x 1,5 mm <sup>2</sup> 1800-2300 kW/10-16 A/3 x 1 mm <sup>2</sup>
	1L, N, PE: 100 V ~ 50/60 Hz	1350 kW/15 A/3 x 1,5 mm <sup>2</sup> or 1350 kW/15 A/3 x 16 AWG	
Water supply and disposal	Internal fresh water tank	s	s
	Mains water supply	s	s
	Waste water outlet	o	o
	Monitored waste water tank	o	o
	Aquachange	s	s

s Standard  
o Option

## Headquarters

### **Schaerer AG**

Allmendweg 8  
4528 Zuchwil  
Switzerland  
info@schaerer.com

[www.schaerer.com](http://www.schaerer.com)

## Subsidiaries

### **Schaerer USA Corporation**

2900 Orange Avenue, Suite 102  
Signal Hill, CA 90755  
USA  
info@schaererusa.com

### **Schaerer Deutschland GmbH**

Siechenlach 1  
89173 Lonsee-Urspring  
Germany  
info@schaerer-gmbh.de  
[www.schaerer-gmbh.de](http://www.schaerer-gmbh.de)

### **Schaerer Benelux – Guy van Bogaert**

Boomsesteenweg 608  
2610 Antwerpen-Wilrijk  
Belgium  
info@schaerer.be

